

Data Sheet



Article number: 0111017

Description: Retaining ring G 6

Measures

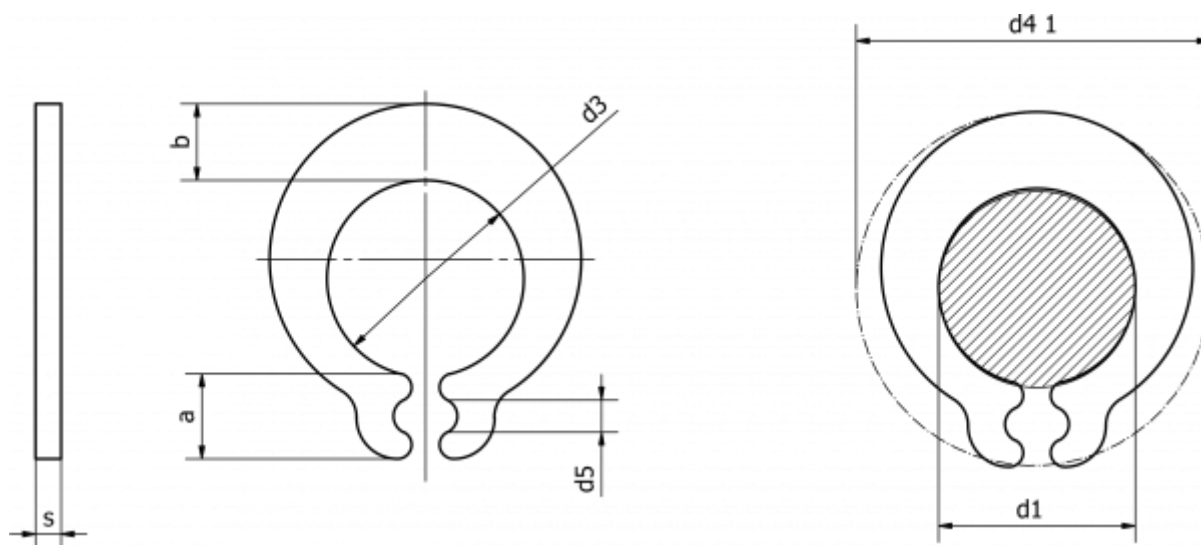

a max	= 3.2	n abl x 1000	= 81
b	= 2.4	s	= 1.00
d1	= 6.0	tol	= 0.075
d3	= 5.70	Tong	= ZGG-1
d4 1	= 12.6	Weight kg/1000	= 0.402
d5 min	= 1.4		
Description	= G 6,0		
Holding force N	= 170		